



# LIFTOFF

Leading the lifting game since 2002

WINNTEC

2T  
OK

8 717202 645306

TY SERIES

CE UK CA

EC.NET



Workshop Essentials 2024 Q3/Q4





# Winntec Workshop Essentials

## Contents

01.

### Wheel Handling Equipment

Smart Carts / Smart Disc / Wheel Assist ERGO+ / Wheel Lift / Wheel Dollies

02 - 05

02.

### Lifting Equipment

Floor Jacks / Long Chassis Jacks / (Air) Bottle Jacks / Air Service Jacks  
Balloon Jacks / Forklift Jacks / Scissor Lifts

06 - 19

03.

### Workshop Equipment

Foldable Crane / Pit Jack / Engine Stand / Industrial Presses / Jack Stands  
Fast Lock Jack Block / Collision Repair Kit / Wheel Removal Kit

20 - 29

04.

### Jack the Mech

Mobile Energy & Air / Detailing Seats / Jumpstarter

30 - 31

05.

### Liftpads & Merchandise

Liftpad X, S & EV / Standard Liftpads / Winntec Merchandise

32 - 33



Le Mans, France 2024

## Reaching new Heights

We manufacture, develop and supply top-quality, efficient, and dependable automotive workshop essentials that are competitively priced and supported by exceptional customer service and support.

In the coming years, our primary focus is on lifting, handling, and transportation safety & ergonomics.

We understand the challenges mechanics face, both in workshops and on the road. As the quantity of heavy items (both vehicles and their commodities) increases, we believe it is our responsibility to supply cost-effective solutions that will save time and significantly reduce any risk.

Our second focus is ease of use.

Our products are known to be operator-friendly and excel in ergonomics.

Winntec products are designed & manufactured in compliance with NEN-EN 1494:2001+A1:2008 CE UK.







# Wheel Handling Equipment

## By Winntec

### Y471147 HD Classic - Smart Cart Ø 76 cm

The original Smart Cart that changed the industry! This long life, light weight, high capacity cart allows the tire fitter to maneuver heavy wheel sets in the most ergonomic way with the help of its PATENTED LOADSHIFT TILTING SYSTEM. The unique push-slide-secure automatic locking system eliminates the need for inefficient, wear sensitive, foot-operated or hand controlled jaws. The foam filled tires are maintenance free and leave no traces. It comes in powder coated steel with high strength components.

Specifications	
Height =	1385 mm
Width =	610 mm
Depth =	695 mm
Range Ø =	up to 76 cm
	220 kg
	20,5 kg

#### Main Features

- SUPERIOR ERGONOMICS
- Flat-free tires leave no stripes
- Handles tires and wheel assemblies





### Y4711SPP - Extender & Push Pull Kit

Extend the height of your Smart Cart with the retro-fit extender. The Push-Pull lever ensures a quick release on smooth, polished floor or when dealing with a light stack of tires.



### Y471123 - Smart Disc



Keep those wheel sets mobile in your showroom and workshop! Stack, roll and grab them with (or without) your Smart Cart.

Specifications	
Ø	68 cm
	160 kg
	3,7 kg



### Y472270 - Wheel Assist ERGO+



Operating as a standalone piece of workshop equipment, that doesn't require charging or linking up to a power source, the Winntec® Wheel Assist has powerful gas springs that enable workshop technicians to quickly and easily remove and replace wheels while in an ergonomically correct position (chest height). This unique, patent pending product, allows the operator to install wheels at chest height.

Specifications	
Height	1800 mm
Width	685 mm
	45 kg
	42 kg



### Y471148 HD Dominator - Smart Cart Ø 83 cm

Our new Smart Cart with PATENTED LOADSHIFT TILTING SYSTEM, suits tire techs that transport tires and wheel sets all day long in and around the shop and at racetracks. It picks up even bigger wheels than its predecessor, while its integrated kick pedal ensures a quick release of 'the load'. The redesigned, stronger, sleeker arms in stainless guarantee a perfect catch and grip of the heaviest wheels and wheelsets. Your Dominator comes with a bracket set to easily carry a Smart Disc along.

Specifications	
Height =	1385 mm
Width =	610 mm
Depth =	695 mm
Range Ø =	up to 83 cm
	220 kg
	23,3 kg

#### Main Features

- REQUIRES 3x LESS EFFORT TO TILT/LIFT BY MAKING USE OF LOADSHIFT™ TECHNOLOGY
- 3+7 YEARS WARRANTY (upon activation)
- Auto open/close stainless grippers
- Height-adjustable top plate with rubber grips
- Foot Control Bar for better load manoeuvring
- Spring-operated kick pedal
- Handles tires and wheel assemblies





### Y471148EXT - Extender Kit

OPTIONAL bolt-on/off extender with rubber grips to increase the carrying capacity of the DOMINATOR to 8 tires. Easy installation and removal. Highly recommended for those who transport large stacks of tires.



### Y471105 - Wheel Dolly

Remove wheel assemblies quickly & efficiently. Its ergonomic design reduces the chance of (back strain) injuries. Equipped with adjustable extended rollers and rubber wheels with a steel core.

Specifications	
Frame size	700*1000 mm
	220 kg
	15 kg



#### Main Features

- QUICK DETACH HANDLE
- Extended rollers - 290 mm



### Y471106 - Truck Wheel Dolly

This lightweight, portable dolly with hydraulic unit to ensure precise positioning, allows the operator to work on a very short distance from the vehicle, perfect for road assistance service work. Its shock absorbing casters ensure a smooth ride from and to the hub.

Specifications	
Frame size	900*450*310 mm
	160 kg
	29 kg



#### Main Features

- CARRY HANDLE & BELT
- Maximum mobility
- Fast positioning



### Y472280 - Wheel Assist NXT

Quickly and easily remove and replace wheels while at an ergonomically correct position. It allows the operator to lift and lower wheel assemblies from floor to shoulder height. Trigger control ensures variable speed. Operates with Makita/Milwaukee batteries.

Specifications	
Height	1730 mm
Width	930 mm
	70 kg
	45 kg







***Our Smart Carts  
and Wheel Assists  
form a great team  
and work in line with  
each other.***



# Lifting Equipment Floor Jacks

When we founded Winntec in 2002, we rebuild the hydraulic floor jack from scratch. The result was an innovative, operator-friendly, and servicable design that combined European and American features and functionality.

Today we have the most complete hydraulic jack range in the game, with capacities ranging from 1.35 to 32 tons.

**TURBO LIFT** and **2-SPEED LOWERING** are two of many technologies we implemented since then. What started out as distinguishing factors have now become standard features for almost all of our jacks. Their quality, safety and ease of use are – and remain – at the heart of our operations.

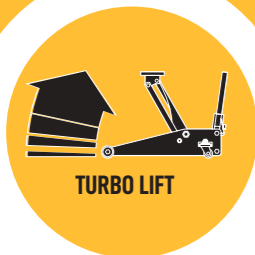

## TURBO LIFT

Makes your jack ascend quickly when using the foot pedal.



## 2-SPEED LOWERING

Makes your jack descend slowly under load, yet fast without.



Model	Min H.	Max H.	Size (W x L)	Capacity	Weight (KG)
Y411350	80	375	236 x 501	1.35 T	10 kg
M411355	90	360	247 x 481	1.5 T	14.2 kg
Y411202	86	418	282 x 625	2 T	22 kg
Y420222	75	500	350 x 705	2 T	42 kg
Y420250	75	510	343 x 686	2 T	32,5 kg
Y420330	120	450	344 x 618	3 T (US)	31 kg
Y420333	76	503	346 x 672	3 T	37 kg
Y420336	95	540	350 x 688	3.6 T	38.5 kg

## Y411350 - Full Aluminum Jack 1,35T

Easy maneuverability and high stability under load. Thick frame side plates and a reinforced lift arm result in added strength. A bypass and overload valve prevent from over-extension of hydraulic ram and jack use beyond rated capacity. The two-piece handle with quick lock offers easy storage.

Specifications	
Min. H. =	80 mm
Max H. =	375 mm
Width =	236 mm
Length =	501 mm
Capacity	1,35 T
Weight	10 kg



### Main Features

- ONLY 10 KG!
- Nylon wheels
- Rubber saddle pad

## M411355 - Full Aluminum Jack 1,5T

Light-weight jack from our Winntec Motionline with advanced features. Comes in a colored box.

Specifications	
Min. H. =	90 mm
Max H. =	360 mm
Width =	247 mm
Length =	481 mm
Capacity	1,5 T
Weight	14 kg



### Main Features

- 2-SPEED LOWERING
- TURBO LIFT
- Rubber saddle pad

## Y411202 - Aluminum/Steel Jack 2T

Light-weight design combined with TURBO LIFTER technology. The PU wheels minimize noise and potential (showroom) floor damage. The jack starts at 86mm and reaches 418 mm maximum height.

Specifications	
Min. H. =	86 mm
Max H. =	418 mm
Width =	282 mm
Length =	625 mm
Capacity	2 T
Weight	22 kg



### Main Features

- 2-SPEED LOWERING
- TURBO LIFT
- Foot pedal
- PU wheels
- Rubber saddle pad







## Y420250 - Ultra Low Floor Jack 2T

Ultra low profile design combined with TURBO LIFTER technology. The jack starts at 3in and reaches an impressive 510mm at maximum height. The PU wheels minimize noise and potential (showroom) floor damage. A rubber grip and saddle pad, which prevents damage to the underside of the chassis, are standard features.

Comes with heat-treated chromed pump pistons and chromed main ram. Like all our other jacks, it is equipped with cardan transmission, which makes the jack very smoothly maneuverable.

### Specifications

Min. H. =	75 mm
Max H. =	510 mm
Width =	343 mm
Length =	686 mm
 T	2 T
 kg	32,5 kg



Y490000  
GUARANTEED  
PERFECT  
FIT!  
Y490010EV



OUR  
BEST  
GOT EVEN  
BETTER!





### Main Features

- 2-SPEED LOWERING
- TURBO LIFT
- Rubber saddle pad
- PU wheels

## Y420222 - Ultra Low Floor Jack with Integrated Jack Stand Function 2T

This ultra-low floor jack (75 mm) is equipped with an integrated jackstand function and has a maximum lifting height of 500 mm. Hold-to-run control. The poly-urethane wheels are noise reducing and prevent damage to floors. The saddle is covered by a rubber pad that prevents damage to the underside of the chassis. The handle is covered by a handle bumper that prevents damage to the car.

### Specifications

Min. H =	75 mm
Max. H =	500 mm
Width =	350 mm
Length =	705 mm
 T	2T
 kg	42 kg



### Main Features

- INTEGRATED JACKSTAND FUNCTION
- 2-SPEED LOWERING
- TURBO LIFT
- Hard-chromed ram and pistons
- Auto-lock
- Rubber pad





DUAL  
PURPOSE  
LIFT/SUPPORT



## Y420330 - Low Floor Jack 3T(US)

Comes with noise-reducing PU wheels, a rubber pad/grip and our TURBO LIFTER pump system. The release valve allows you to lower heavy loads in a controlled way. The main ram and both pistons are chrome plated. Winntec selected the best industrial grade seals and gaskets for its next best seller.

### Specifications

Min. H. =	120 mm
Max H. =	450 mm
Width =	344 mm
Length =	618 mm
 T	3 T (US)
 kg	31 kg



### Main Features

- 2-SPEED LOWERING
- TURBO LIFT
- Rubber saddle pad
- PU wheels



Y490000  
GUARANTEED  
PERFECT  
FIT!  
Y490010EV





EXCELLENT  
PRICE -  
QUALITY  
RATIO

## Y420333 - Ultra Low Floor Jack 3T

This jack unites the ultra-low-profile design and high reach, our unique 2-SPEED LOWERING technology, TURBO LIFT pump system, 3T capacity and noise reducing PU wheels. The highest quality of components will ensure maximum performance and life time.

### Specifications

Min. H. =	76 mm
Max H. =	503 mm
Width =	346 mm
Length =	672 mm
 T	3 T
 kg	37 kg



### Main Features

- 2-SPEED LOWERING
- TURBO LIFT
- Rubber saddle pad
- PU wheels
- Foot pedal





Y490000  
GUARANTEED  
PERFECT  
FIT!  
Y490010EV



## Y420336 - Low Floor Jack High Reach 3,6T

Its 3.6T capacity and low entry height combined with a high reach of 540mm set this jack apart from its competitors. A rubber grip, rubber pad and handle bumper are included. The jack benefits from a fully welded power unit that shows chromed pistons and chromed main ram. Equipped with industrial quality polyamide wheels, dual speed lowering and TURBO LIFT technology.

### Specifications

Min. H. =	95 mm
Max H. =	540 mm
Width =	350 mm
Length =	687 mm
 T	3,6 T
 kg	38,5 kg



### Main Features

- 2-SPEED LOWERING
- TURBO LIFT
- Rubber grip
- Polyamide wheels
- Rubber pad
- Welded pump



Y490000  
GUARANTEED  
PERFECT  
FIT!  
Y490010EV



MAX HEIGHT  
540MM





© Copyright Top Gear

***It is no wonder that  
we have 500.000+  
active lifting  
devices in the field.***



# Lifting Equipment

## Long Chassis Jacks

### Long Chassis Jacks 2-10T

Our Long Chassis Jacks are built for heavy duty lifting. They come with foot pedals for quick lifting and ergonomically designed handles with a release button to gradually lower the jack. Furthermore, these jacks are equipped with an automatic overload safety valve and durable swivel castors.

#### Jack dimensions

A = Min. Height (mm) B = Max. Height (mm) C = Width (mm) D = Length (mm) E = Height (mm)

Model	A	B	C	D	E	Capacity	Weight (kg)
Y420200	138	800	396	1310	1285	2 T	58
Y420301	130	600	325	1400	1330	3 T	65
Y420500	150	680	366	1505	1345	5 T	90
Y421000	160	680	485	1635	1355	10 T	145

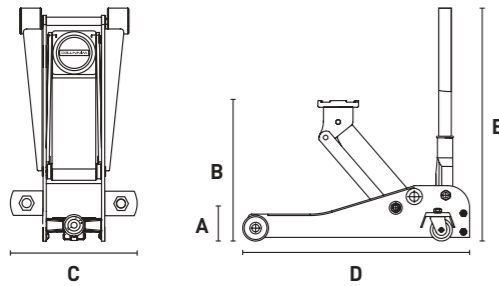

# Lifting Equipment

## Bottle Jacks

### Bottle Jacks 2-30T

Versatile for use in a large variety of applications: pushing, bending, pressing or straightening. The full range comes with cast iron bases, polished main rams and a solid, chromed pump linkage. These jacks are tested to the latest European standards, have overload protection and can be used in both horizontal and vertical positions. All models (except Y413000 & Y411000) have a twist top for precise height adjustments.

The telescopic Y411000 comes with two extensions (45 mm & 6 mm), internally machined oil passages, smooth bearing surfaces and close tolerances.



#### Main Features

- CHROMED PISTONS
- Easy maintenance
- Heat-treated saddle



#### Jack dimensions

Model	Base plate (mm)	Min H. (mm)	Lifting H. (mm)	Adjust H. (mm)	Max H. (mm)	Capacity	Weight (kg)
Y410200	96 x 93	158	90	60	308	2 T	2.3
Y410400	112 x 104	180	110	60	350	4 T	3.3
Y410600	116 x 116	197	125	60	382	6 T	4.4
Y410800	120 x 120	205	125	60	390	8 T	5.4
Y411000	180 x 118	120	100	-	260	10 T	6.4
Y411200	140 x 135	214	125	60	399	12 T	7.2
Y411500	140 x 140	225	140	60	425	16 T	8.3
Y412000	155 x 140	244	145	60	449	20 T	10.5
Y412001	155 x 140	190	90	60	340	20 T	9
Y413000	175 x 160	285	180	-	465	30 T	14.6

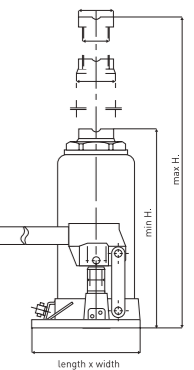



# Lifting Equipment

## Air Bottle Jacks

### Y432020 - Air Bottle Jack 20T

Among the toughest in the market. Equipped with an air regulator, a chrome ram, a welded base, and return springs so that these jacks will keep on working no matter the job. Each unit is hand-tested before shipping to guarantee maximum reliability.

#### Main Features

- WELDED BASE
- Extension screw
- High speed air motor
- Chromed ram



### Y432021 - Low Profile Air Bottle Jack 20T

This unit includes a welded base to prolong service. Chrome main ram and aluminum air motor guarantee optimum lifetime. Air filter and air regulator connected to hose, included. Does not offer a manually operated pump.

#### Main Features

- WELDED BASE
- Extension screw
- High speed air motor
- Chromed ram



### Y432021 - Air Bottle Jack On Trolley 20T

This model features a specially heat treated cylinder wall and chrome piston, ensuring premium performance and durability. Can be stored vertically.

#### Main Features

- WELDED BASE
- Can be stored vertically
- High speed air motor
- Chromed ram



Model	Base plate (mm)	Min H. (mm)	Lifting H. (mm)	Adjust H. (mm)	Max H. (mm)	✂️	📏 (kg)
Y432021	180 x 115	148	66.6	45	260	20 T	9
Y432020	220 x 175	245	150	80	475	20 T	16.5
Y432003	300 x 150	253	150	80	483	20 T	25.7





# Lifting Equipment

## Air Hydraulic Jacks

### Y432024 - Single Stage Air Service Jack 20T

This single stage air service jack delivers a massive 24 Ton of power and comes with premium interior hydraulic and pneumatic components. It is designed to meet and exceed expectations of a quality jack at a very competitive market value. The controller allows for the jack to ascend and descend with air. No more relatively unsafe, manual descending of heavy trucks! This Y432024 comes with 3 extensions (20mm, 50mm & 100mm) and is equipped with an 85mm extension screw. The heavy duty wheels have been designed for daily use.

Model	A	B	C	D	E	F	G		
Y432024	215	141	85	525	1240	265	441	24 T	40
Y432032	150	73	66	480	1300	290	289	32/16 T	38

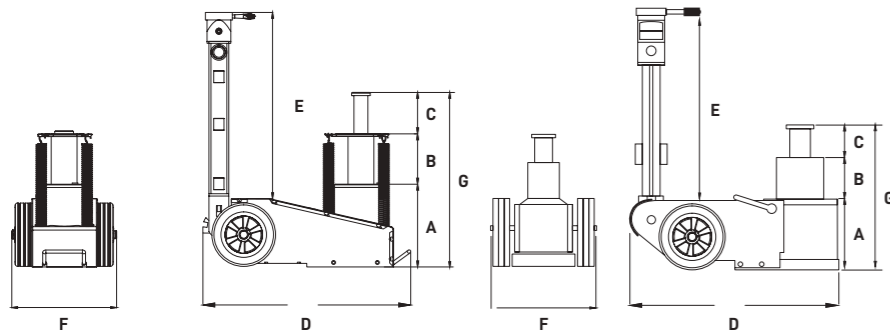

### Y432032 - Telescopic Air Service Jack 20T

Dual stage air service jack with a low entrance height of just 150mm and hard chromed piston. It's 32/16 Ton capacity and compact dimensions, make this jack ideal for both workshop and road assistance duty. Air-controlled ascend and descend ensures maximum safety. Comes with 2 extensions (45mm & 100mm). As an option we offer a 260mm extension.

#### Main Features

- HARD CHROMED PISTONS
- Pneumatic descend
- Dead-man control

#### GT260MM-EXT

260mm extension for Y432032



#### Main Features

- HARD CHROMED PISTON
- Pneumatic descend
- Dead-man control
- Extension screw

**AIR CONTROLLED DESCENT**

**LOW CLEARANCE - MAXIMUM MOBILITY**



# Lifting Equipment

## Balloon Jacks

### Y422002 - Pneumatic Balloon Jack 2T

Lifts extremely fast and can easily be placed on a car lift. A safety valve prevents from over inflation, while the internal telescopic stabilizer (ASTM-513 steel) provides stability.

#### Main Features

- IDEAL ON 4 POST LIFT
- 2-Stage Low Profile Balloon Jack
- Internal telescopic stabilizer
- Turn saddle for precise height control
- Safety valve



#### Specifications Y422002

A = 300 mm	A' = 360 mm
B = 125 mm	B' = 185 mm
D = 400 mm	
	2 T
	14,8 kg

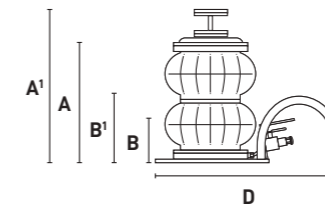

### Y422012 - Pneumatic Balloon Jack 2T

Our Y422012 equipped with a handle and wheels for easy positioning under the vehicle.



#### Specifications Y422012

A = 300 mm	A' = 360 mm
B = 125 mm	B' = 185 mm
D = 1100 mm	
E = 280 mm	
	2 T
	16 kg

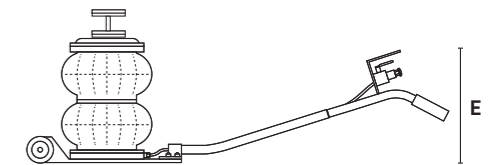

# Lifting Equipment

## Forklift Jack

### Y454000 - Forklift & Tractor Jack 4/5T

Forklift jack with dual lifting points (4/5T), 2-Speed Lowering, chromed ram and chromed pump piston. Lower, extended arm is only 65mm for easy access under forklift trucks. The upright piston at 416mm is ideal for lifting tractors and farm machinery. Hydraulic lift 355mm on forklift arm and 350mm on upright piston.

#### Main Features

- WELDED BASE
- 2-Position lift pad
- High-strength frame work

#### Specifications

Max. Height	425 mm
Min. Height	65 mm
	4/5T
	45 kg

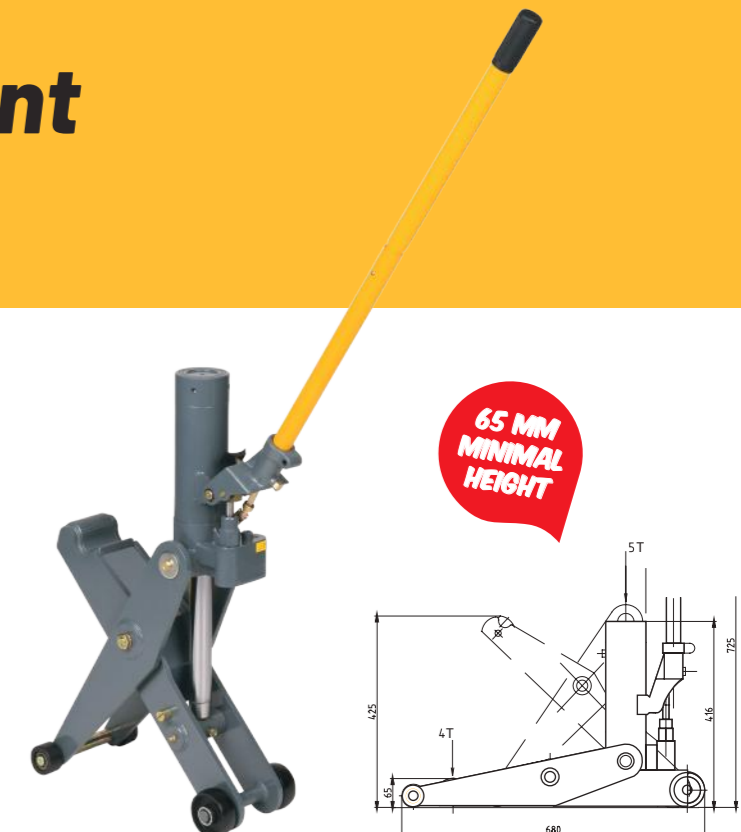

**65 MM MINIMAL HEIGHT**

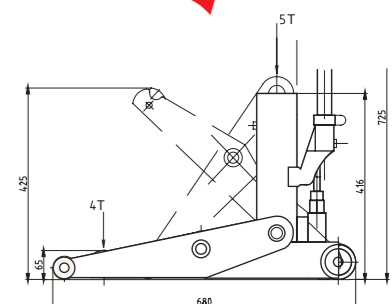





# Lifting Equipment Scissor Lifts

## Y475054 - Ultra Low Scissor Lift 3.5T

- AUTOMATIC BALANCING
- Self-lock function of dual circuit hydraulic system

Specifications	Y475054
Width	480 mm
Length	1400 mm
Min. H. - Max. H.	105-1000 mm
Capacity	3500 kg
Weight	690 kg
Operation pressure	0.6 - 0.8 Mpa
Rated voltage	25 Mpa
Power voltage	230 V
Motor power	2.2 KW
Lifting time	50 - 60 sec



## Y475230/400 - Ultra Low Scissor Lift 3.2T

- EXTEND TO 78.75" WHICH SUITS MOST CARS AND SUV'S
- Automatic balancing & self-lock function of dual circuit hydraulic system

Specifications	Y475230 - Y475400
Width	585 mm
Length	1460 mm
Min. H. - Max. H.	105-1900 mm
Capacity	3200 kg
Weight	810 kg
Operation pressure	0.6 - 0.8 Mpa
Rated voltage	25 Mpa
Power voltage	230 / 400 V
Motor power	2.2 KW
Lifting time	50 - 60 sec



## Y475051 - IN-SYNCH2 2.5T

Open undercarriage access, portable and easy to maneuver. Smooth perfectly in-sync lifting and lowering ensured by our patented valve blocks. Quick-connect fittings make it easy to assemble/disassemble.

TECHNICAL DATA	
Frame width	300 mm
Frame length (lowest position)	1910 mm
Min. H. - Max. H.	85 - 455 mm
Lifting point spread (Min.)	800 mm
Lifting point spread (Max.)	1320 mm
Weight	95 kg



## Y475052 - RAZZO1 1.8T

Mini lift with mechanical safety lock. Extremely versatile lift, operated with an industrial, airhydraulic footpump, which allows you to quickly lift and support any small/large car, vans and SUVs.

TECHNICAL DATA	
Length (arms withdrawn)	1120 mm
Length (arms extended)	1910 mm
Width	400 mm
Min. H. - Max. H.	110 mm - 630 mm
Weight	113 kg





# Workshop Equipment

## Crane, Gearbox & Engine Service

# Workshop Equipment

## Industrial Presses

### Y440104 - Foldable Crane 1T

Constructed from heavy gauge welded square tubular steel. The 2-speed hydraulic pump with chromed ram rotates up to 135 degrees ensuring the optimal working position. Fine adjustment lowering handle with dead man's control, nylon wheels avoid floor damage, 3 pre-set positions for lifting and easy to maneuver.

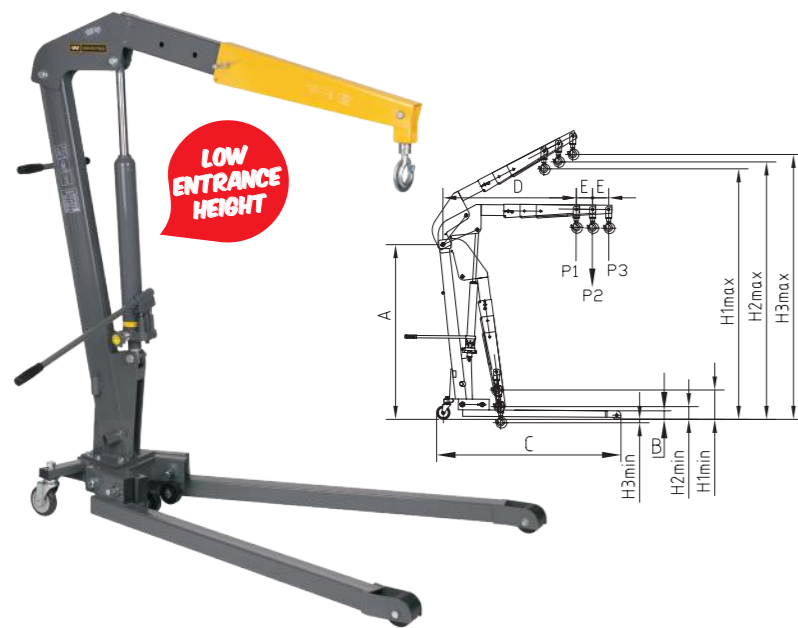

P1	1000
P2	750
P3	500
A	1405
B	80
C	1499
D	1009
E	125
H1min	334
H2min	214
H3min	94
H1max	2120
H2max	2210
H3max	2300
74 kg	

### Y440105 - Engine Leveler

Drop-forged steel engine leveler (550 kg) with heat-treated fully adjustable chains. Comes with two 1000 mm load chains.



### Y451555 - Transmission Jack 500KG

Its superior stability and efficient pump system ensure a fast and precise approach. Suitable for installing and dismantling gearboxes, engines & couplings.

Min H.	Lifting H.	Max H.	Height	Width		
1171	817	78.3	22.6	21.3	1,212.5	69

#### Main Features

- DEAD-MAN CONTROL
- Wide base with swivel wheels
- Fast approaching speed
- Block foam to protect vehicle parts
- Turnable saddle

### Y451555ADAP - Adapter

Adjustable arms and 360° rotatable handle. Locking pin secures in any of the 8 positions.



### Y450102 - Engine Stand 500KG

Adjustable arms ensure ease and speed. Rotate 360° with the handle. A locking pin secures in any of the 8 positions.

Specifications	
Height	860 mm
Width	750 mm
Length	760 mm
	450 kg
	19 kg



### Industrial Presses 15-50T

Our presses with welded frame are suited for standard pressing, bending, bonding and straightening jobs. Essential for the removal/installation of universal joints, bearings, pulleys, and wrist pins. Includes 2 V-blocks for easy and secure positioning.

#### Y461520 - Press 20T

- 2-SPEED HAND PUMP
- Sliding cilinder



#### Y461533 - Press 30T

- 2-SPEED HAND PUMP
- Movable cylinder (left-right)
- Pneumatic foot operation



#### Y461555 - Press 50T

- 2-SPEED HAND PUMP
- Movable cylinder (left-right)
- Pneumatic foot operation



#### Y461516 - Press 15T

- BENCH MODEL
- 2-SPEED HAND PUMP



Model	Height (mm)	Depth (mm)	Width (mm)		
Y461516	1015	134	678	15 T	57,5
Y461520	1830	540	850	20 T	101
Y461533	1850	540	840	30 T	137
Y461555	1850	650	1080	50 T	244

## Accessories

Y461533-PS - Punch Set    Y4615XX-PC - Protective Cover







**Both our Smart Carts  
are motorsport's 1st  
choice because of  
their ruggedness  
and ease of use.**





# Workshop Equipment

## Jack Stands



### Y450350 - Fast Lock Jack Block 3.5T

Your new must-have for any job project. This clever device is a valuable addition to your workshop because it does more than just support your floor jack - it **replaces your jack stand!** It works perfectly with most floor jacks, but is especially useful for lifting electric vehicles (EVs). With its impressive adjustability from 217 mm to 352 mm, it adapts to different vehicle heights. Installation is quick and easy, with a spring mechanism for hassle-free use. For extra security, use the included safety pin and you're ready to work on your vehicle, safely.

Specifications	
Min. H =	217 mm
Max. H =	352 mm
3,5 T	
1,7 kg	



### Y450301 - Jack Stand Ratchet Type 3T

- RATCHET TYPE
- AUTOMATIC LOCKING
- Carrying handle



### Y451600 - Jack Stand Ratchet Type 6T

- RATCHET TYPE
- AUTOMATIC LOCKING
- Carrying handle



### Y452300 - Jack Stand Pin Type 3T

- PIN TYPE
- LARGE PU SUPPORT PAD



### Y452600 - Jack Stand Pin Type 6T

- PIN TYPE
- LARGE PU SUPPORT PAD



### Y452330 - Jack Stand Pin Type 3T

- PIN TYPE
- LOW PROFILE
- 4" REPLACABLE PU SADDLE PAD
- Base with extra big foot pads for increased stability

JUST 11.8 IN  
MIN. HEIGHT  
RECOMMENDED FOR  
MODEL 3 &  
MACH-E

NEW!





# Workshop Equipment

## Jack Stands for Truck

### Y451205 - Low Profile Jack Stand SET 12T

Low profile jack stand with handle and wheels for easy positioning under the vehicle. The pin type support column adjusts to 5 different height positions. A 8.7in square base secures and stabilizes load.

#### Main Features

- PIN TYPE
- Low profile handle
- Nylon wheels



### Y452205 - High Reach Jack Stand SET 22T

Heavy duty, welded, wheeled jack stand set with detachable handle. Multi-angle handle sockets ensure easy storage and safe positioning under the vehicle.

#### Main Features

- PIN TYPE
- Nylon wheels



### Y451206 - High Reach Jack Stand 12T

Heavy duty, high reach welded jack stand with detachable handle, multi-angle handle socket and wheels for easy positioning under the vehicle.

#### Main Features

- PIN TYPE
- Nylon wheels



Model	Min H. (mm)	Max H. (mm)	W	L	Ø (mm)	Weight	Capacity
Y450301	305	450	185	209	-	3 T	7
Y452300	322	465	-	-	254	3 T	5,2
Y452330	300	451	279,5	-	310	3 T	9
Y451600	395	625	263	293	-	6 T	13,8
Y452600	404	604	-	-	341	6 T	11,2
Y451205	302	450	280	220	-	12 T	20
Y451206	601	971	423	370	341	12 T	29,2
Y452205	402	575	333	280	-	22 T	42,4





# Workshop Equipment

## Miscellaneous

### Y444000/Y444100 - Collision Repair Set 4-10T

Both 4T (Y444000) and 10T (Y441000) include solid blow cases, chromed rams/pistons and safety valves to prevent from overloading. Their heavy gauge snap-together pipework and cast attachments are compatible with most leading brands of body repair equipment.

Supplied with the following parts:

Single Speed Hand Pump • Cylinder (100mm stroke Y444000 - 150mm stroke Y444100) • Hose • Ram Flat Base • Spreader • 100mm Extension Tube • 150mm Extension Tube • 300mm Extension Tube • 400mm Extension Tube • Tube Coupling • Ram Toe • Wedge Head • Serrated Saddle • Flex Head • Plunger Toe • 90 Degrees Wedge Head • Storage Case

#### Main Features

- PIN TYPE
- Low profile handle
- Nylon wheels

Model	Cylinder	kg	kg
Y444000	4	4 T	17
Y444100	6	10 T	31



### Y471180 - Wheel Removal Kit 10T

This kit eliminates one of the most dangerous jobs within the tire service industry: WHEEL REMOVAL! Alloy and light steel wheels are often frozen (glued) to the vehicle.

This ready-to-use kit includes a case, cylinder, pump, hose and a variation of adaptors to be installed depending on the space between the wheel and the chassis of the vehicle. With 10 Ton of hydraulic power and manual control of the foot pump, it becomes a safe and quick job to press the oxidized wheel from the vehicle.

#### Main Features

- ALL-IN-ONE SOLUTION
- Foot operated
- Metal case

Specifications	
Height =	150 mm*
Width =	480 mm*
Depth =	235 mm*
kg	10 T
kg	15 kg

\* Case Dimensions



**AVOIDS INJURIES & SAVES TIME**

### Y4781107 - Single Acting Cylinder 42-52mm 10T

Made out of high-strength alloy steel for maximum safety and durability. Unique heavy duty spring ensures fast piston return. Equipped with industrial 3/8-18NPT connections.



# Workshop Equipment

## Miscellaneous

### Y471150 - Air Hydraulic Pump 1600cc

For use with a variety of rams, presses and hydraulic tools operating up to 700bar/10,000 psi. Air exhaust muffler for quiet operation. Aluminum housing. Two stage release mechanism; pump, hold or release with pedal control.

Air inlet: 1/4  
Air outlet: 3/8  
Working pressure: 6-10 bar  
Weight: 7,9 kg

### Y471120 - Hydraulic Combi Bead Breaker 5T

Designed to work on all single, two and three pieces 2-5-10 hole buds, 7.5x16s and all tubeless tire/rims. Includes 3 claws. Working range up to 120mm. Self-retracting. Durable anti-corrosive finish.



### Y4781155 - Single Acting 2-Speed 900cc 70 Mpa

Light weight, high flow industrial pump with baked enamel finish to increase corrosion resistance. The compact design ensures efficient storage and transportation. Less handle effort to minimize operator's fatigue. Internal pressure relief valve prevents from overload situation.

Industrial 3/8-18NPT outlet.  
Weight: 6,8 kg

### Y478205 - Hose Assembly 2.5m

Compatible with Y471150 and Winntec Bead Breaker model Y471120.



**LOW OPERATING FORCE**

### Y491110 - Mechanic Gloves M-L-XL

A sturdy glove with protectors for professional work in the workshop.

#### Main Features

- IMPACT PROTECTION
- Slip free silicone grip
- Double stitched
- Industrial hook and loop
- Machine washable



### Y491310 - Precision Gloves L-XL

Perfect for a variety of automotive service jobs that demand a 'fine touch'.

#### Main Features

- FINE TOUCH
- Anti Slip
- Breathable stretch
- Abrasion resistant
- Terrycloth thumb
- Touch screen proof





# Winntec JTM Series Jack The Mech

Designed for the pro - available to all

Winntec's Jack The Mech products are renowned for their high quality and durable construction. They are simple to use and adaptable to users with different degrees of experience, making them a reliable choice for professionals and enthusiasts alike.

Introduced in 2022, 20 years after the founding of Winntec, the Jack the Mech range is characterised by its focus on home tinkerers and professionals alike.



**LITHIUM ION A-GRADE**

## JTM200010 - Mobile Energy & Air

This mobile battery booster is an indispensable tool for your boat, motorhome, caravan or car. It is also an ideal product for car dealers to be used daily in your workshop, showroom or car park.

### Main features

- **START BOOSTER** 2000A
- **COMPRESSOR** auto-start-stop 10 bar / 145 PSI
- High capacity power bank 55.5 wh
- Multifunctional LED light



## JTM400000 - Detailing seat

The ideal addition to any garage or detailer! Perfect for precise detailing of wheels, tires, exhaust tips, and more, or for use in paint repair and polishing of side panels, bumpers, and lights!

### Main features

- **CARBON STEEL INNER FRAMING**
- Premium swivel casters with 2 locks
- Cradle style seating with onboard storage
- Comfortable height



## JTM101224 - Mobile Energy

This 12/24V start booster offers a massive capacity of 10.000A and is an indispensable tool for daily use by roadside service mechanics. Prior to a start attempt, the clampsensors warn you when they measure resistance.

### Main features

- **START BOOSTER** 10.000A 12V / 5.000A 24V
- Multifunctional LED light
- Multiple safety functions integrated



# Liftpads

## Dedicated Pads

### Y490000 - Liftpad X

LIFTPAD helps to lift safely & reduces the risk of damaging your vehicle's chassis and lifting point! Fits most floor jacks, perfect fit guaranteed with our: Y411202, Y420250, Y420303, Y420330, Y420333, Y420336.

#### Main Features

- UNIVERSAL FIT
- PFAS & PAHS FREE
- Avoids frame rail damages
- Avoids lift point deformation

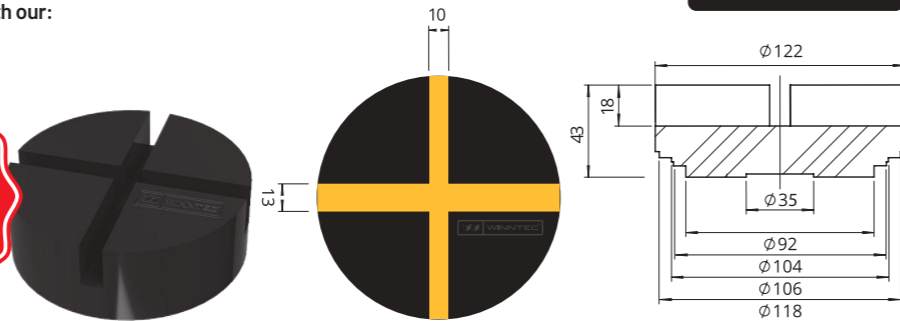

### Y490020 - Liftpad S

LIFTPAD helps to lift safely & reduces the risk of damaging your vehicle's chassis and lifting point! The pad has a 75mm diameter slot that is 15mm deep for compatibility with most brand-specific adapters. Fits most floor jacks, perfect fit guaranteed with our: Y411350 & M411355.

#### Main Features

- UNIVERSAL FIT
- PFAS & PAHS FREE
- Avoids frame rail damages
- Avoids lift point deformation



Model	Y490000	Y490010EV	Y490020
Top ø =	112 mm	112 mm	110 mm
Height =	43 mm	20 mm	43 mm
Base slot ø =	92 mm	92 mm	80 mm
Base slot 2 ø =	104 mm	104 mm	-
Base slot 3 ø =	106 mm	106 mm	-
Base slot 4 ø =	118 mm	118 mm	-
X-groove =	10/13 mm	-	10/13 mm
KG	400 gr	150 gr	300 gr



### Y490010EV - Liftpad EV

An essential piece of equipment for raising cars that need a lifting adaptor. The pad has a 75mm diameter slot that is 15mm deep for compatibility with most brand-specific adapters. It stays on the jack more firmly thanks to magnets on the bottom.

Fits most floor jacks, perfect fit guaranteed with our: Y411202, Y420250, Y420303, Y420330, Y420333, Y420336.



\* Adapters not included!

### Y411350-42 - Fully Covering Saddle Pad Yellow

Perfect fit guaranteed with our: Y411350.



### Y420250-34 - Inlay Saddle Pad

Perfect fit guaranteed with our: Y420250, Y420330 & Y420333.



### Y420336-42 - Inlay Saddle Pad

Perfect fit guaranteed with our: Y420336.

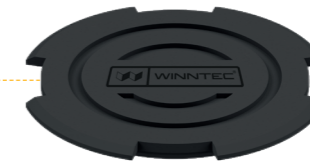

### Y411202-45 - Fully Covering Saddle Pad Black

Perfect fit guaranteed with our: Y411202, Y420250, Y420330 & Y420333.



## Merchandise

### Miscellaneous

### Y490025 - 2D XL Keychain



### JTM120220 - 2D XL Keychain



### Y490088 - Cap L-XL



### M120110 - Smart Fast Charger

- VEHICLE VOLTAGE INDICATOR 12-24V
- USB-A 3.0 & USB-C
- Fast charging
- Alloy casing
- LED light



### Y490033 - Lunch Bag



### Y490022 - Backpack XL

- WATERPROOF
- FLOATS ON WATER
- Extra spacious
- 100% PVC



GREAT PROMO ITEM!





Winntec® is a brand owned by TMG  
 Rechtaad 6, 4703 RC Roosendaal  
 The Netherlands  
 +31 165 561 613 | info@winntec.net

winntec.net

We  Jacks



WINNTEC  
 Y411202  
 NO  
 NO  
  
  
 OIL VOLUME  
 1.5L - 1.800ml  
 HEAVY DUTY  
 TURBO LIFTED  
 FAST  
 3 SPEED LOWERING  
 WINNTEC